

17

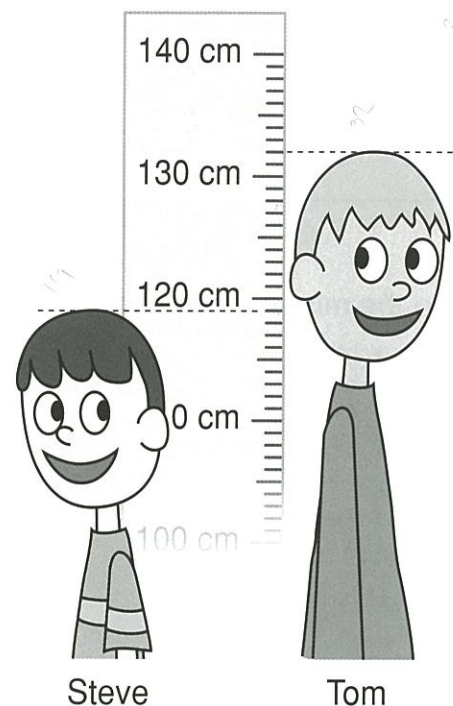

How much taller is Tom than Steve?

7 cm
A

11 cm
B

13 cm
C

17 cm
D

18 A girl is making berry muffins using this recipe.
How many cups of berries will she need to make only 12 muffins?

Berry Muffins

Makes 24 muffins

$\frac{2}{3}$ cup sugar

1 cup milk

150 grams butter

1 cup self-raising flour

$1\frac{1}{2}$ cups berries

$\frac{1}{4}$ cup
A

$\frac{3}{4}$ cup
B

1 cup
C

3 cups
D

19 This picture shows one-quarter.

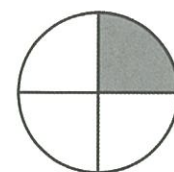

Which of these also shows one-quarter?

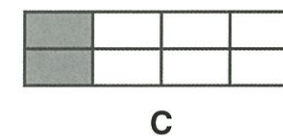
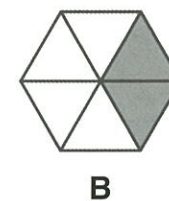
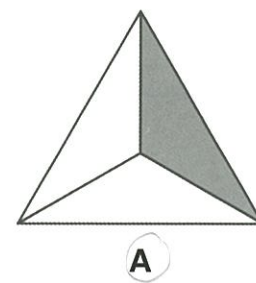

20 A flower pot is placed in front of a mirror as shown.



What does its mirror image look like?



21 Yukti wants to know what are her friends' favourite snacks.
What is the best way to collect this information?

- A List snacks and ask each friend to choose their favourite.
- B Search the Internet for "friends' favourite snacks".
- C Ask the local shopkeeper which snack is the most popular.
- D Look in the bins for different snack wrappers.

22 The heights of five students are:
120 cm, 132 cm, 140 cm, 125 cm, 130 cm.
Which graph best shows their heights?

- A bar graph
- B tally chart
- C pictograph
- D** circle graph

23 A group of students were surveyed about their favourite type of movie.

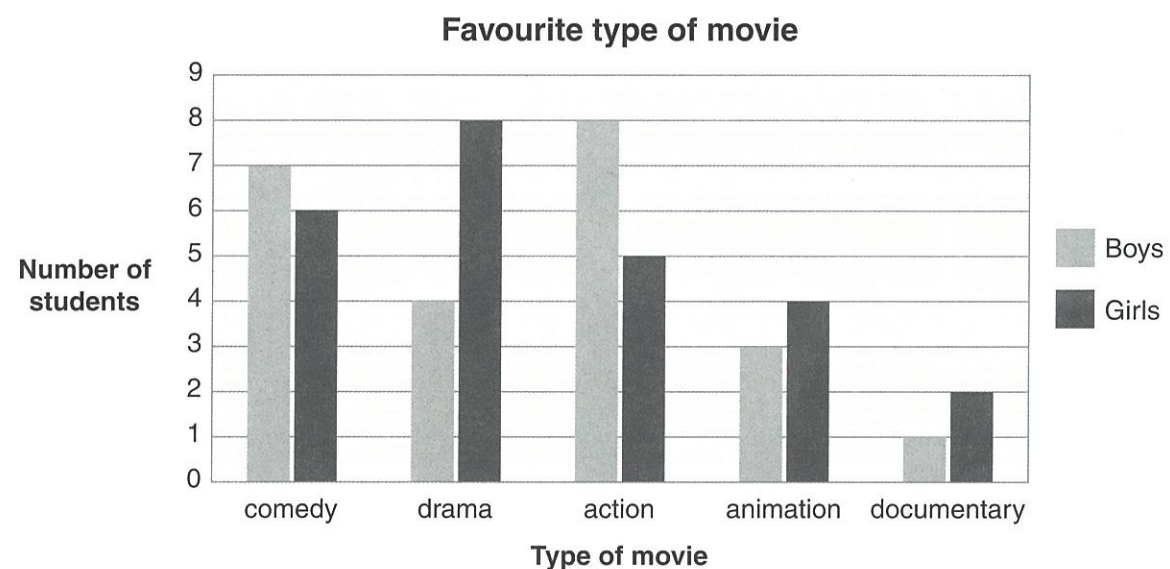

How many **boys** chose animation?

- A** 3
- B 4
- C 7
- D 8

14 What is 85.92 rounded to the nearest tenth?

- 85 **A**
- 85.9 **B**
- 86.0 **C**
- 90 **D**

15 Which picture shows the reflection of the triangle in the mirror line?

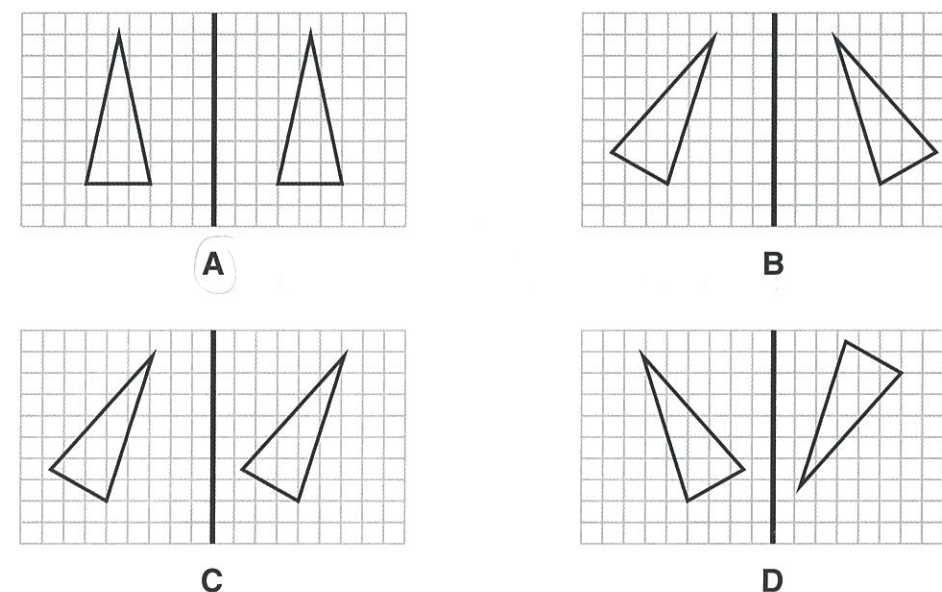

16 This graph shows the number of children going to different school clubs.

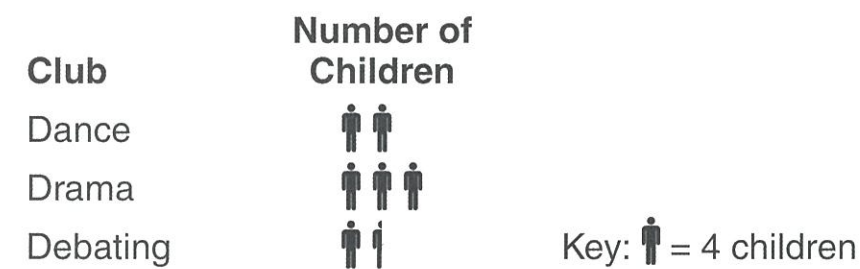

How many children take part in a club?

- 7 **A**
- 24 **B**
- 26 **C**
- 28 **D**

12 This picture shows the seating arrangements for a concert.

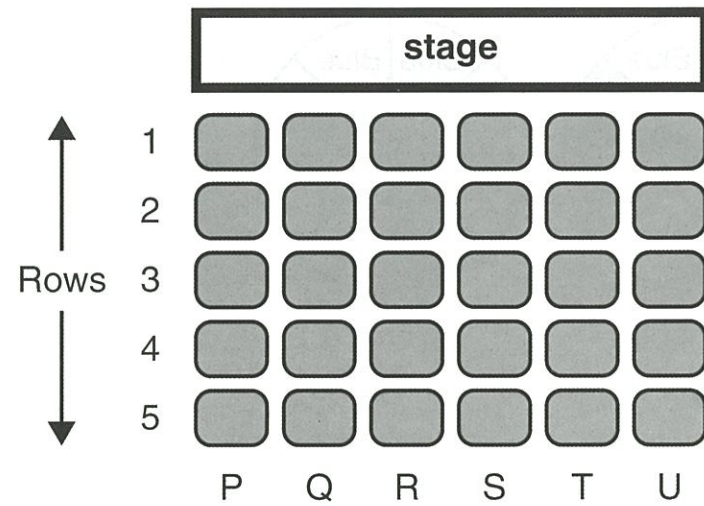

A boy is sitting on the third seat from the left of the second row.

Where is he sitting?

- Q2 Q3 R2 R4
A **B** **C** **D**

13 Which figure shows the largest fraction shaded grey?

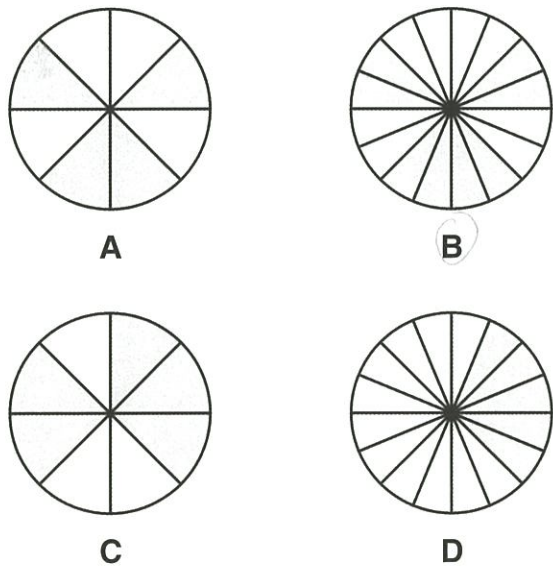

24 The bar graph shows the vegetables produced on a farm.

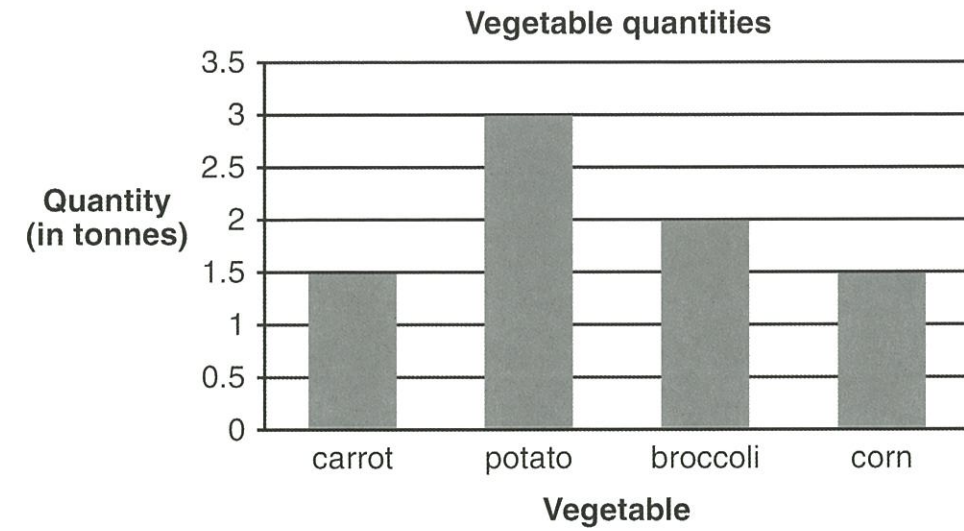

What is the total production of the farm in tonnes?

- 7 8 9 10
A **B** **C** **D**

25 Which unit on a measuring tape gives the most accurate measurement?

- kilometre metre centimetre millimetre
A **B** **C** **D**

26 Which method will give the answer to 50×19 ?

- $50 \times 20 - 50$ $50 \times 20 - 20$ $10 \times 50 + 9$ $10 \times 50 - 9$
A **B** **C** **D**

27 A ribbon 124 metres long will be cut into 5 equal pieces.

Each piece must be as long as possible. Each piece must be a whole number of metres.

How much ribbon will be left over?

- 1 m 4 m 5 m 24 m
A **B** **C** **D**

28 Annie cuts this shape from cardboard. She folds it to make a box.

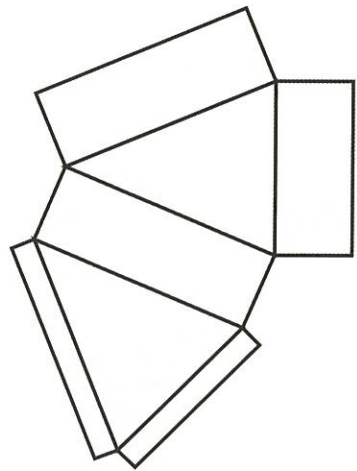

What is the shape of the box?

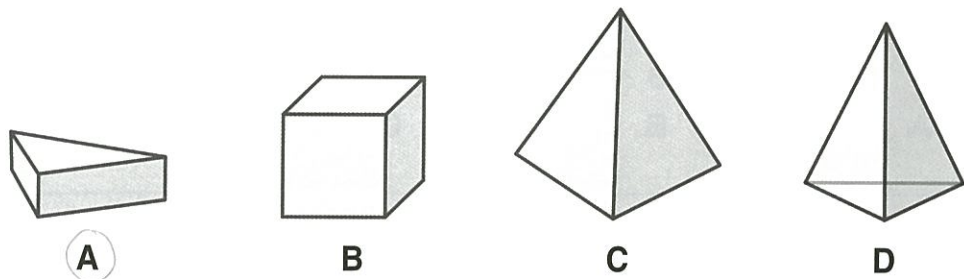

29 A football stadium has 80 000 seats.
63 258 seats have been sold for a game.
How many seats have **not** been sold?

63258
- 16742

46516

- 16 742 17 258 23 258 26 742
- A** **B** **C** **D**

30 A boy takes one ball from each of the bags below without looking.
From which bag will the boy most likely take a black ball?

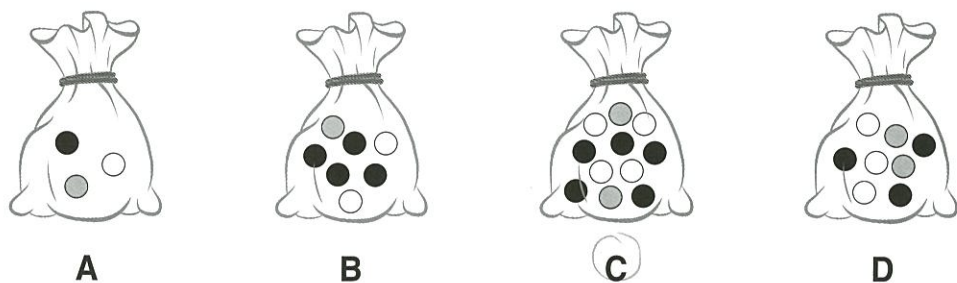

10 Which spinner shows an equal chance of getting blue and red?

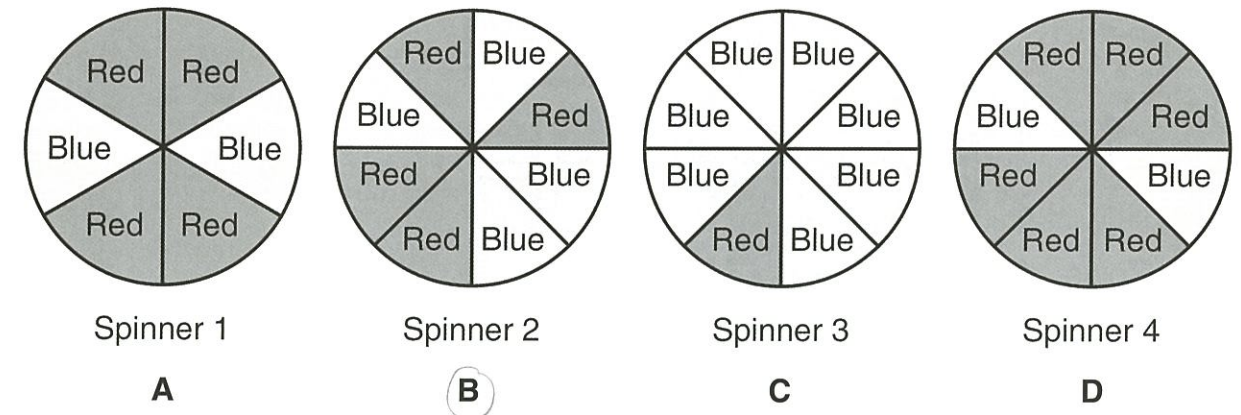

11 Which two shapes have the same area?

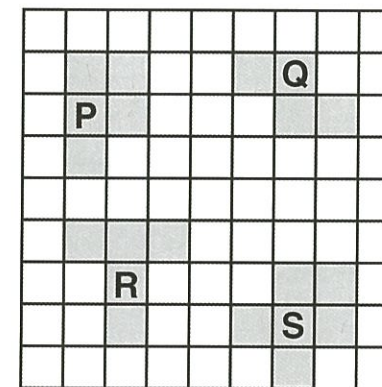

- A** shapes P and Q
B shapes Q and R
C shapes R and S
D shapes P and R

7 This grid has 100 squares; 25 of the squares are shaded.

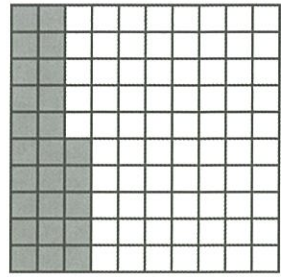

What fraction of the grid is shaded?

- A** $\frac{2}{5}$
 B $\frac{1}{4}$
 C $\frac{3}{10}$
 D $\frac{20}{100}$

8 Which jug contains half a litre of water?

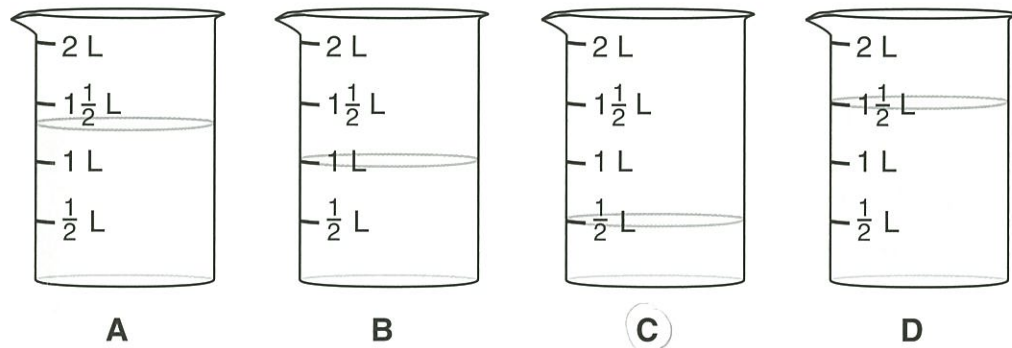

9 This piece is one-third of a circle.

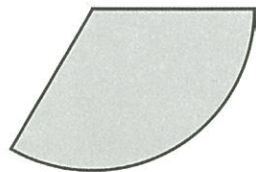

How many of these pieces make a whole circle?

- A** 1
 B 2
 C 3
 D 4

31 Which improper fraction is equal to $10\frac{2}{7}$?

- A** $\frac{27}{7}$
 B $\frac{102}{7}$
 C $\frac{20}{7}$
 D $\frac{72}{7}$

32

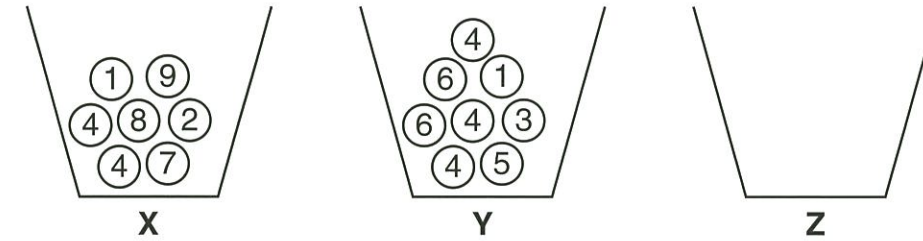



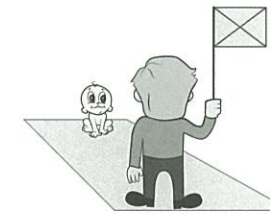

The numbered discs from buckets X and Y are tipped into bucket Z. The discs are then mixed around and one disc is chosen at random. What is the probability that this disc has an odd number on it?

- A** $\frac{3}{15}$
 B $\frac{6}{15}$
 C $\frac{6}{56}$
 D $\frac{9}{56}$

33 A man holds up a flag to a baby. What does the baby see?



- A** 
 B 
 C 
 D 

34 Which gives an answer closest to 9×22 ?

- A** 5×25
 B 5×20
 C 10×25
 D 10×20

35 How many small dogs would weigh the same as the big dog?

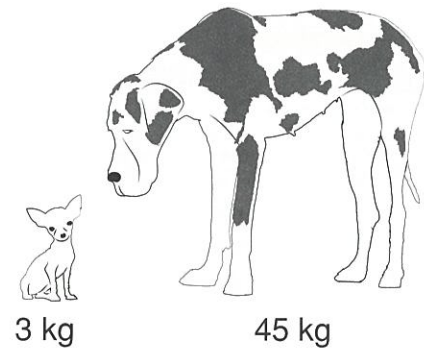

- 15 21 42 48
 A B C D

36 A girl sits on a roundabout in a playground. She is facing the pond.

She is turned $\frac{3}{4}$ of a turn clockwise, then $\frac{1}{2}$ of a turn anti-clockwise, then $\frac{3}{4}$ of a turn anti-clockwise.

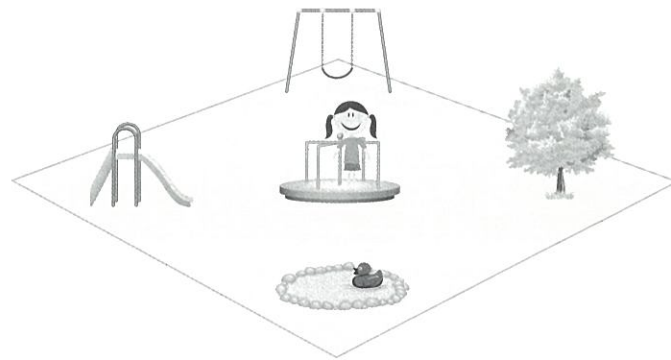

What is she facing now?



37 What does this box look like when it is opened?

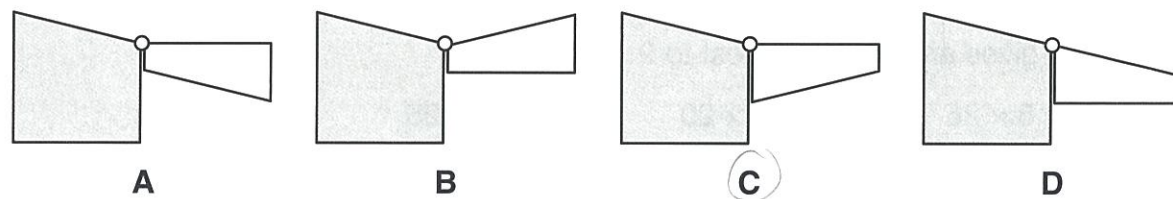
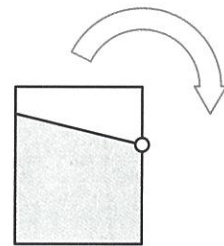

5 A woman walks from the train station to the restaurant.

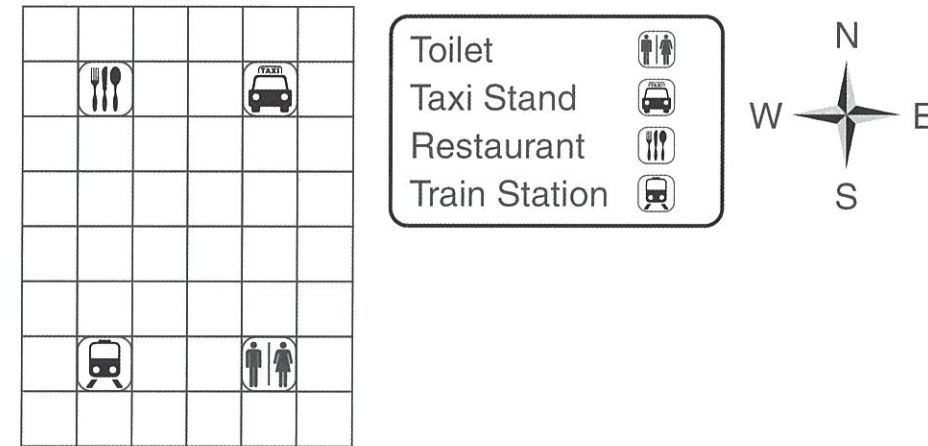

In which direction does she walk?

- North South East West
 A B C D

6 A girl needs to pack 45 balls into some boxes. Each box must hold the same number of balls.

She must use the smallest number of boxes.

Which box should she use?

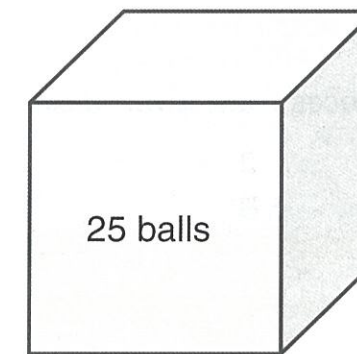
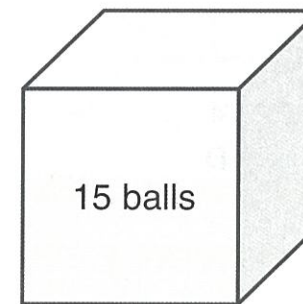
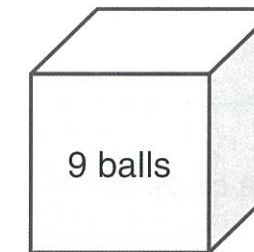
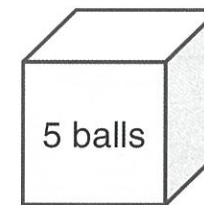

1 Three 50 centimetre rulers are placed on a line.



What is the total length?

- 50 cm 1 m 1 m 50 cm 15 m
A **B** **C** **D**

2 What is 6.75 hours in hours and minutes?

- A** 6 hours and 3/4 minutes
B 6 hours and 45 minutes
C 6 hours and 75 minutes
D 7 hours and 15 minutes

3 How many tens are there in 5482?

- 48 82 482 548
A **B** **C** **D**

4 The shaded part of each circle shows a fraction.

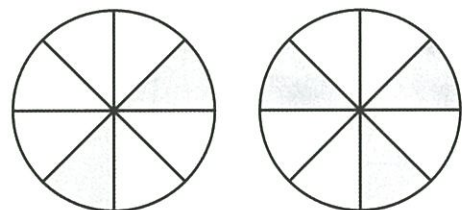

Which shaded circle shows the sum of the two fractions?

- A** **B** **C** **D**

38 A football team won 3 more games than it lost.
 The team played 15 games.
 There were no drawn games.
 How many games did the team win?

- 8 9 12 13
A **B** **C** **D**

39

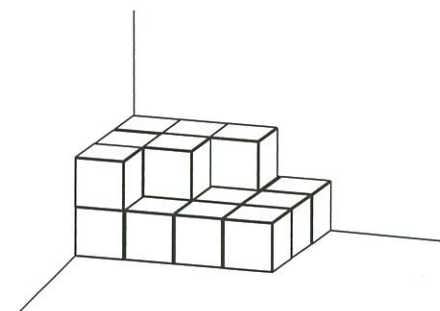

Ann stacks these boxes in the corner of the room. All the boxes are the same size.
 How many boxes does she use?

- 25 19 18 13
A **B** **C** **D**

40 Amy leaves her house and walks 2 blocks south, 3 blocks west and 5 blocks north.
 Where does she finish?

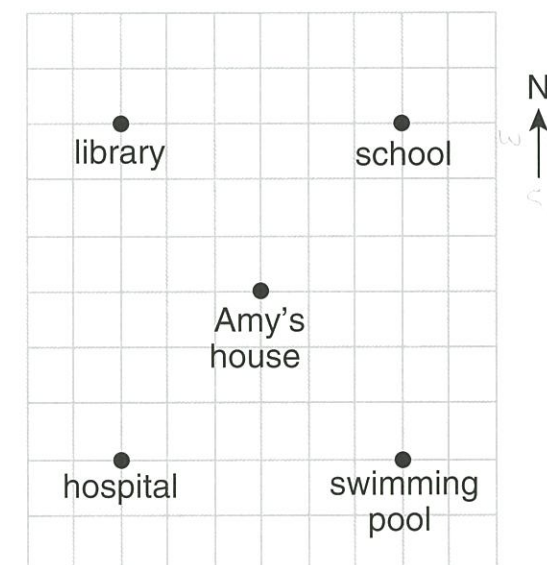

- library school hospital swimming pool
A **B** **C** **D**



Mathematics



STUDENT NAME Sarina Kooshan
 NAME OF SCHOOL Towheed Iranian School

TEST INSTRUCTIONS

FILL IN YOUR DETAILS

Turn to your ANSWER SHEET and fill in your name, school, grade, section, today's date, your date of birth and gender.

ANSWERING QUESTIONS

Go to the MATHEMATICS ANSWER SHEET.
 This test has **40 QUESTIONS**. Each question has four possible options.
 Choose the **BEST** answer from the four options, **A, B, C** or **D**.
 FILL in **ONE** circle on your answer sheet with a pencil.
 If you make a mistake, erase the pencil mark and fill in a different circle.
 You must colour the entire circle as shown below:

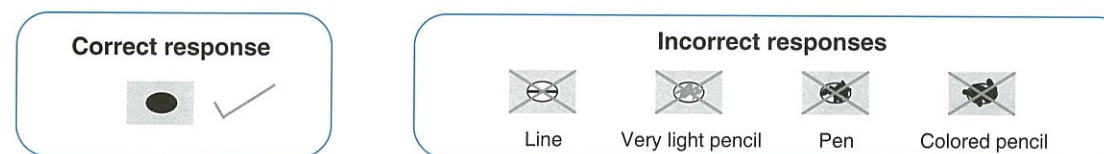

Marks are NOT deducted for incorrect answers.

ALL ANSWERS SHOULD BE MARKED ON YOUR ANSWER SHEET ONLY.

EQUIPMENT ALLOWED IN THIS TEST

You may use a 2B or B pencil for this test. You may NOT use a calculator for this test.

TIME ALLOWED FOR TEST

The time allowed to complete this test is **60 minutes**.